

Varenummer: 204350M12125D1S
 Beskrivelse: E+G Justerfod
 GN 43-50-M12-125-D1-S
 Note: S Uden møtrik, udvendig sekskant i bunden

Mål

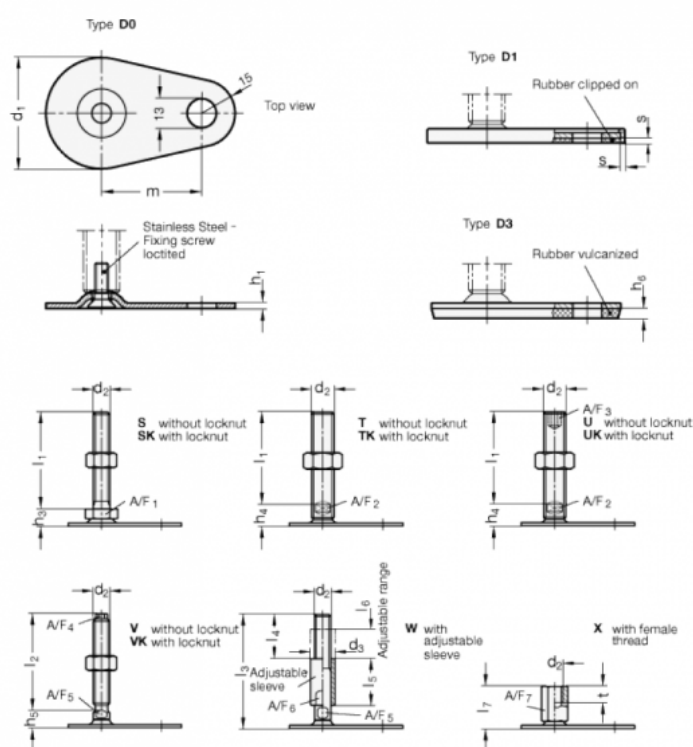

A/F1 = 17	s = 2
d1 = 50	
d2 = M12	
h1 = 2.5	
h3 = 11	
h6 =	
l1 = 125	
m = 45	